

# MiniRaQ<sup>(TM\*)</sup> Installation Overview

Congratulations on your purchase of the MiniRaQ<sup>(TM)</sup> vertical rack system. The MiniRaQ<sup>(TM)</sup> is available in 4U, 6U and 8U sizes based on size and usage restrictions for a variety of applications. The MiniRaQ<sup>(TM)</sup> is designed from heavy gauge steel and finished to last a lifetime. It is designed to hold up to 400 pounds when properly installed for your most demanding needs such as extended runtime battery back up systems, low profile power distribution transformers, POE equipment and many other rack mountable products.



**Warning** For installing the MiniRaQ<sup>(TM)</sup> System into any other surface not specifically mentioned in this manual, please consult local building code requirements to insure safe and secure installation.

The MiniRaQ<sup>(TM)</sup> System can be mounted on a variety of vertical substrates including wooden framing studs 16" on center, solid or block concrete walls, and approved plywood electrical panel or directly onto existing 2 Post racking. Please see detailed instructions on the following pages.

Mounting hardware is provided for installing into solid wall studs and #12-24 screws for mounting on 2 Post rack. The MiniRaQ<sup>(TM)</sup> can even be mounted in a 2 Post rack Back-to-Back configuration if clearances allow, which may increase U space utilization in some instances.

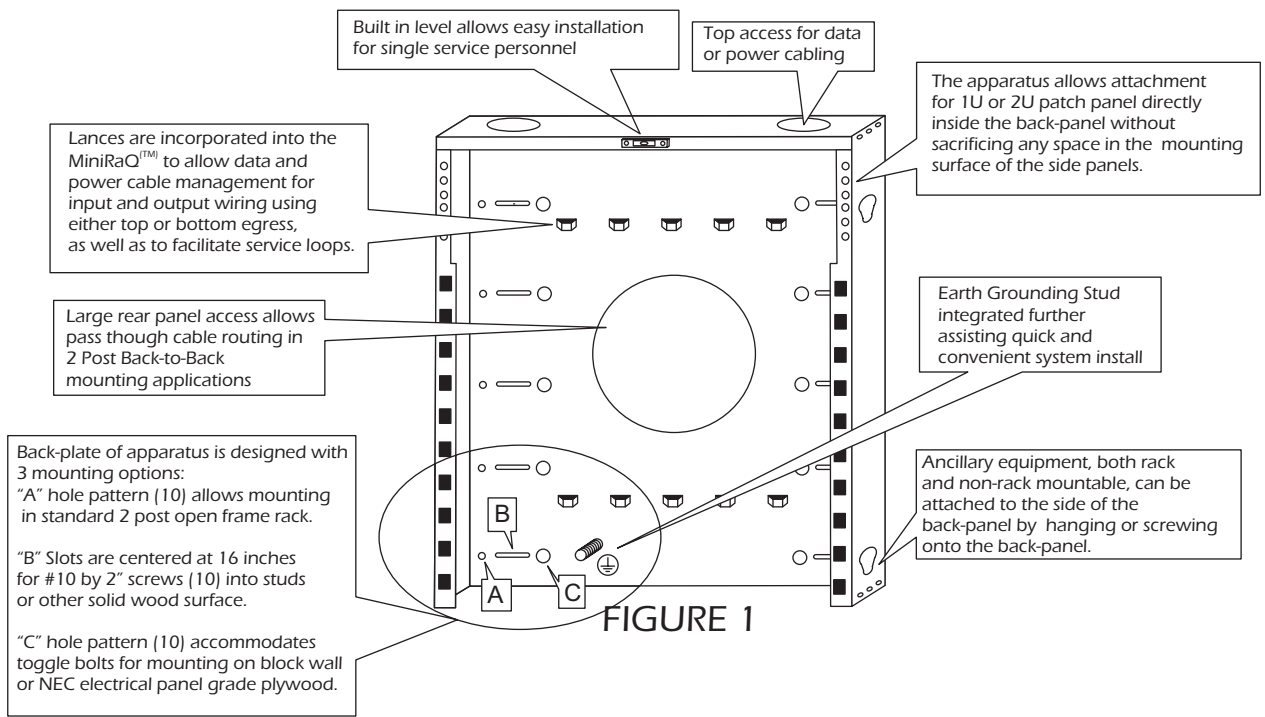

All Trademarks are the property of their respective owners. \*Patents pending.  
BlackHawk Labs, LLC Copyright 2007

# MiniRaQ<sup>(TM)</sup> Detailed Installation Instructions

First confirm that the main back panel of the MiniRaQ<sup>(TM)</sup> will be mounted onto a recommended surface and be sure proper hardware is available to proceed. Hardware is supplied for both 2 Post rack (kit contains 10 #12-24 relay rack screws) and wooden framing studs 16" on center (kit contains 10 #10 x 2" Stainless Steel screws). If installing into concrete or approved plywood electrical panel be sure to have appropriate 1/4" hexhead concrete screws\*\*, lag bolt inserts\* or toggle bolts\* before continuing with installation.

**Note** \*10 fasteners are recommended for full rated load  
 \*\*10 fasteners are recommended for full rated load

Mounting main back panel for MiniRaQ<sup>(TM)</sup>

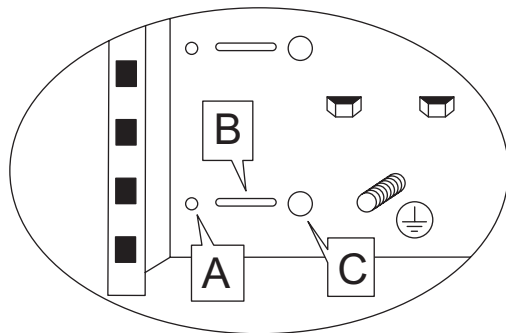

Close up detail of  
 Mounting hole patterns  
 for different hardware options  
 Available to install the  
 MiniRaQ<sup>(TM)</sup> System

FIGURE 2

**2 Post Rack mounting option  
 (Hole Pattern A).....Page 3**

**Mounting into 16 inches on center  
 solid wood wall studs (Hole Pattern B).....Page 4**

**Mounting to Cinder Block or Approved  
 Hollow Wall (Hole Pattern C).....Page 5**

**Mounting to Concrete Wall with  
 Compression Lags (Hole Pattern C).....Page 6**

**Mounting to Concrete Wall with TAPCON® bolts  
 (Hole Pattern C).....Page 6**

**Bracket Installation Details.....Page 7**

**Specifications and Warranty Information.....Page 8**

## 2 Post Rack mounting option (Hole Pattern A)

Using supplied #12-24 screws align and insert 1 screw. Do not fully tight screw but engaged enough to hold up back panel. Using integrated level, adjust panel and add second screw to opposite post. Add remaining 8 screws and then tighten all. Next go to bracket installation details (pg 7).

Begin installing #12-24 Screws at the top using the integrated Level to locate proper mounting pattern. 10 screws recommended for full payload rating of system.

Close up detail of 2-Post Mounting option

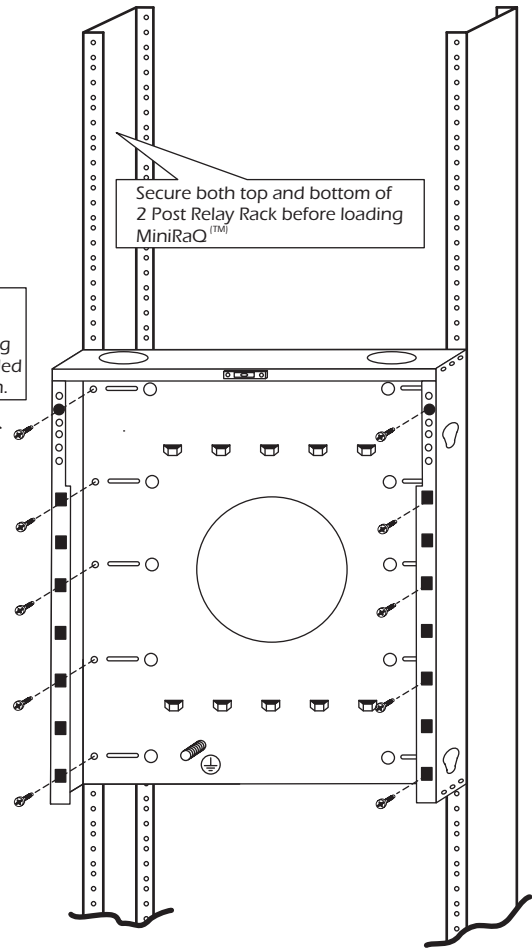
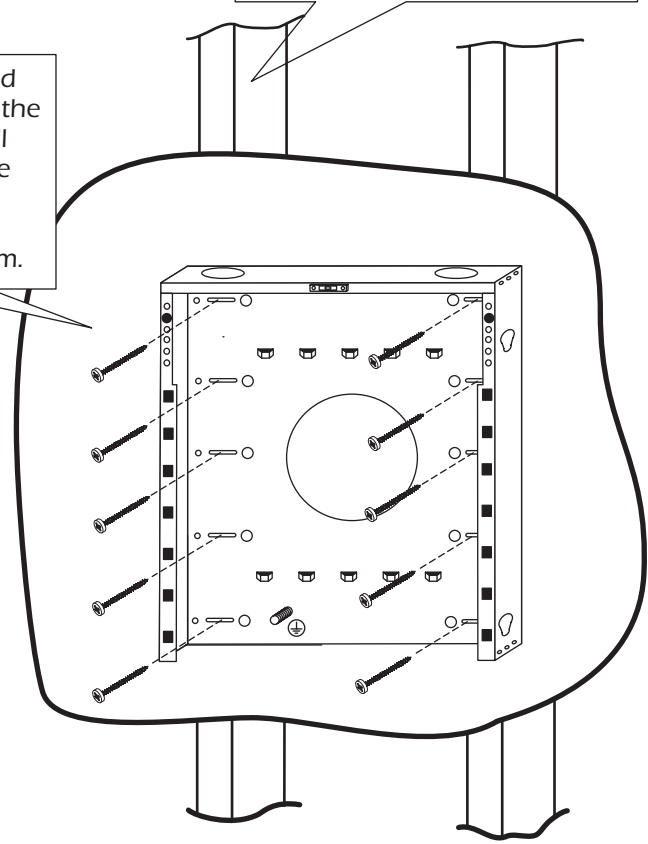

FIGURE 3

## Close up detail of 16" Center to Center Mounting option

Locate solid studs, 16 inches on center before marking top two locations for pilot holes. Drill .156" at the top using the integrated level to locate proper mounting pattern.

Begin installing supplied screws in pilot holes at the top then drill and install remaining screws in the pattern. 10 screws recommended for full payload rating of system.



### Mounting into 16 inches on center solid wood wall studs (Hole Pattern B)

Place the MiniRaQ(TM) main back panel against the wall in the preferred location. Confirm location of stud centers and for at least one TOP pilot hole. Drill pilot hole using 5/32" bit (not supplied). Place the first #10 wood screw through top slot B and insert screw most of the way into stud. Using integrated level, adjust panel and drill remaining TOP Pilot hole and insert screw most of the way into stud. All remaining pilot holes can be drilled and screws inserted into holes as above. Tighten all screws. Next go to bracket installation details (pg 7).

FIGURE 4

## Mounting to Cinder Block or Approved Hollow Wall (Hole Pattern C)

Place the MiniRaQ<sup>(TM)</sup> main back panel against the wall in the preferred location. Using integrated level, adjust panel to level then mark a minimum of the two top and two bottom 1/2 inch clearance holes (Hole C). Drill marked holes and apply Toggles<sup>®</sup> or other associated inserts as required. Lift main back panel and hand tighten bolts and fender washers (not supplied) most of the way into stud. Tighten all screws.  
Next go to bracket installation details (pg 7).



An approved hollow wall application is considered to be either of the following; Cinder Block wall or NEC type 3/4" plywood electrical panel backing using toggle bolts is safe for full rated load of MiniRaQ<sup>(TM)</sup> System.



In the event that this bracket is to be mounted on a block wall 1/4" x 3" toggle bolts should be used to support it. It will be important that the hollow pocket in the block is located so that the toggle can open properly to support the weight. Toggle bolt clearance hole is 1/2" (bolts and washers not supplied; available for purchase separately).

This illustration shows recommended mounting pattern for concrete screws with fender washers

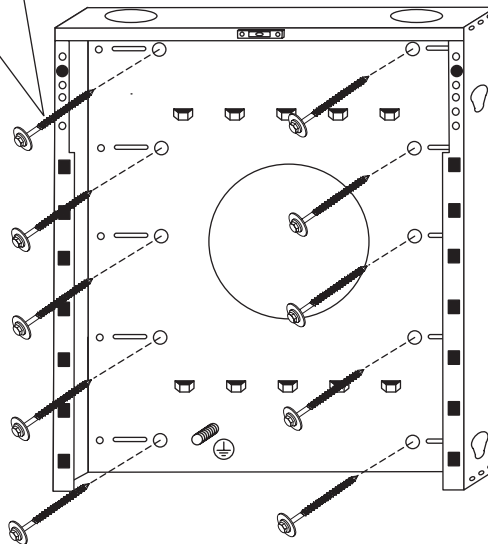

FIGURE 5

## Mounting to Concrete Wall with Compression Lags (Hole Pattern C)

Place the MiniRaQ<sup>(TM)</sup> main back panel against the wall in the preferred location. Refer to Figure 5 on Page 5 for correct mounting hole pattern.

Using integrated level, adjust panel and to level and mark a minimum of the two top and two bottom ½ inch clearance holes (Hole C) Drill marked holes as required and apply compression studs or other associated inserts as required. Lift main back panel and hand tighten bolts and fender washers (not supplied) most of the way into stud. Tighten all screws. Next go to bracket installation details (pg 7).

## Mounting to Concrete Wall with TAPCON® bolts (Hole Pattern C)

Place the MiniRaQ<sup>(TM)</sup> main back panel against the wall in the preferred location. Refer to Figure 5 on Page 5 for correct mounting hole pattern. Using integrated level, adjust panel and to level and mark a minimum of the two top, two bottom and two middle 1/2" clearance holes (Hole C) Drill 5/32" pilot holes for 3/16" bolts, or 3/16" for 1/4" bolts pilot holes as required by manufacturer. Apply TAPCON® or equivalent concrete double threaded screws. A minimum 2 1/4" length is recommended for full rated loading of MiniRaQ. Lift main back panel and hand tighten bolts and washers (not supplied) most of the way into wall. Tighten all screws. Next go to bracket installation details (pg 7).



Caution: The MiniRaQ<sup>(TM)</sup> must be properly installed to a suitable surface and using recommended hardware per instructions provided.

## Bracket Installation Details for MiniRaQ™ System

With the MiniRaQ™ main back panel mounted the left and right brackets can be set in place and secured. The MiniRaQ™ main back panel accommodates all brackets sizes available, 4U, 6U and 8U versions.

Proper orientation is required to secure brackets after engaging the tabs to allow safety screw placement.

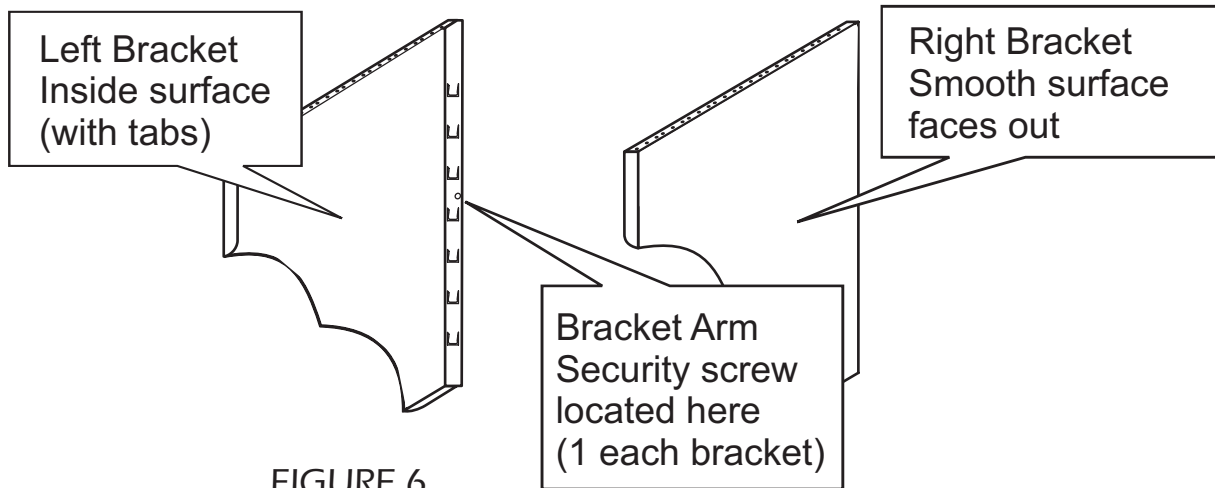

FIGURE 6

Engage one bracket at a time confirming all tabs are nested into cutouts on MiniRaQ™ main back panel (1) and slide down to fully set bracket. The clearance hole in the bracket (2) should now align with a threaded hole in the MiniRaQ™ main back panel. Apply a #12-24 screw (supplied) and tighten. Repeat with opposite bracket.

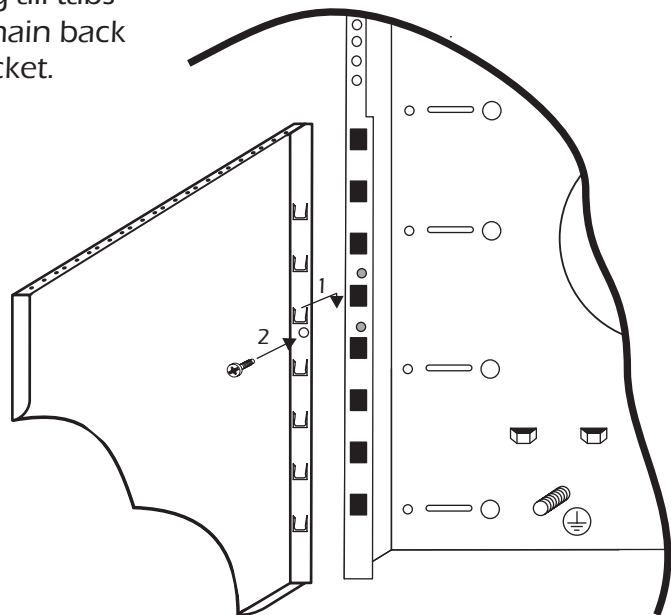

FIGURE 7

## **MiniRaQ<sup>TM</sup> Specifications**

### Item Measurement

Height: 19.25 in (489 mm)

Width: 19.00 in (483 mm)

### Depth:

4U version: 9.50 in (241 mm)

6U version: 13.00 in (330 mm)

8U version: 16.50 in (419 mm)

### Net Weight:

4U version: 13.0 lb (5.9 kg)

6U version: 16.0 lb (7.3 kg)

8U version: 19.0 lb (8.6 kg)

Maximum Equipment Depth 38.00 in (965 mm)

### Effective Rack Mounting Space:

4U version 4U + 2U Patch Panel + 1U each on Sides = 8U

6U version 4U + 2U Patch Panel + 1U each on Sides = 10U

8U version 4U + 2U Patch Panel + 1U each on Sides = 12U

**Total Equipment Weight Capacity: 400.00 lb (181.44 kg)**

**Material: Heavy Duty 14AWG Steel**

**Finish: Chip Resistant Black Powder Coat**

**Shipping Dimensions: 20 X 20 X 3 inches All Versions**

### Shipping Weight:

4U version: 15.0 lb (6.8 kg)

6U version: 18.0 lb (8.2 kg)

8U version: 21.0 lb (9.5 kg)

Pallet Quantity: 48

Specifications are subject to change.





